

# NWCR-12

## Charging rack



Faster • More reliable



# TABLE OF CONTENTS

1	NWCR-12 CHARGER RACK FEATURES .....	2
2	BATTERY CHARGING MECHANISM.....	3
3	TECHNICAL SPECIFICATIONS .....	4
4	STRUCTURAL PARTS .....	5
5	INSTALLATION INSTRUCTIONS .....	9
6	USER GUIDE.....	9
7	MEANING OF THE INDICATOR SIGNAL.....	10
8	TROUBLES AND TROUBLESHOOTING .....	11
9	NOTES.....	12
10	SAFETY WARNINGS .....	13
11	PACKAGE.....	14

# 1 NWCR-12 Charger Rack Features

NWCR-12 Charger Rack is double side charger rack with 12 charging ports. Each charging port is a fast intelligent charger specially designed for New Wisdom KL8M/ KL5M series Lithium battery LED light cap lamp. As a new generation charger rack of New Wisdom, it has the following significant features:

## 1.1 Faster charging

After applying the intelligent fast charging technology, the time to full charge the lamp is much less than before. For the KL5M cap lamp, it takes only 3hours to get full charge; while for the KL8M, less than 5hours is enough.

## 1.2 Higher efficiency, less heat

Compared with the past generations of the chargers, the Charger PCB of NWCR-12 is improved to be more efficient. Even charged in full power, it generates only a little heat.

## 1.3 Wide Range Voltage

Voltage range of the AC power Supply is: 85V~265V

The wide range makes the charger applicable to specific voltage standard in all countries.

## 1.4 Environmentally-friendly

The charger rack is designed in accordance with the Restriction of Hazardous Substances Directive (RoHS). RoHS standard is strictly followed in the whole process, from choosing the material to designing the production technical.

## 2 Battery Charging Mechanism

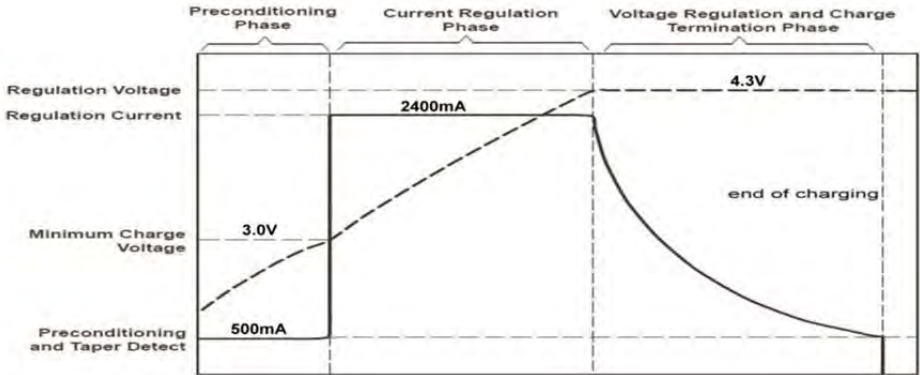

The Lithium-ion battery makes use of both constant current and constant voltage charging methods. The charging current is  $2200\text{mA} \pm 100\text{mA}$  (Max) for MSHA KL5M cap lamp /  $2400\text{mA} \pm 100\text{mA}$  (Max) for non-MSHA cap lamp; voltage is  $4.30\text{V} \pm 0.05\text{V}$  with approximately 4-5hours for charging. The circuit is designed with a steady state charging and control system which automatically regulates the charging process. The circuit we design is near the theoretical charging requirement of the Li-ion battery. For a discharged battery a constant current charge is employed at 2400mA(or 2200mA)  $\pm 100\text{mA}$  (the charger indicator light is red). When the battery voltage reaches 4.30V, the battery switches to a constant voltage charge (at this point the battery is approximately 80% charged) and the current gradually decreases. When the battery is sufficiently charged it automatically cuts off the circuit to protect the battery from over charging (the charger indicator light flashes at green).

**Note:** It is not necessary to wait until the battery is completely discharged before charging. Charging can be undertaken At any stage of the battery capacity and actually it prolongs the life span of the battery if charging is taken before complete discharge.

### 3 Technical specifications

Features	NWCR-12 Specifications
AC input voltage	85~265V , 50~60Hz, 270VA
DC output voltage	4.80V±0.05V (Max)
DC output current	2200mA±100mA (Max) for MSHA KL5M cap lamp 2400mA±100mA (Max)
Size	30 x 23 x 98cm
Weight	19kg

# 4 Structural Parts

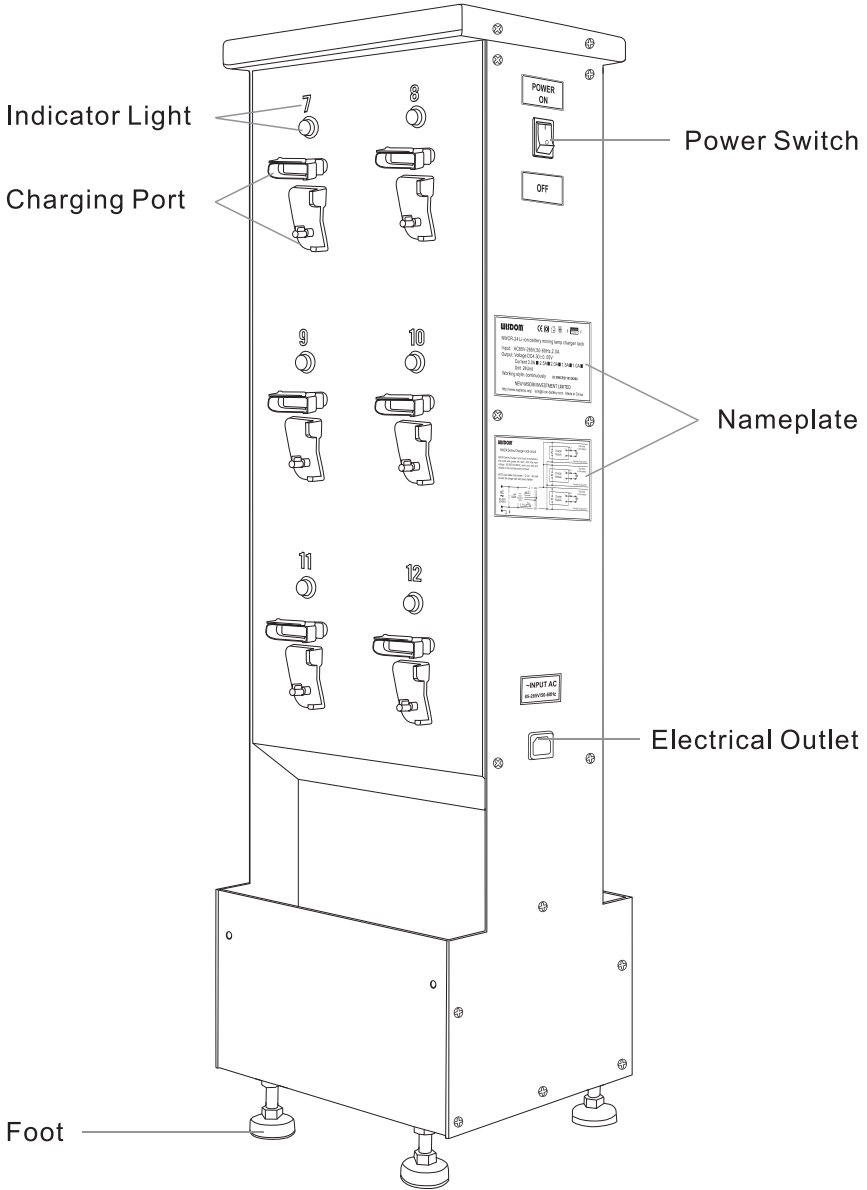





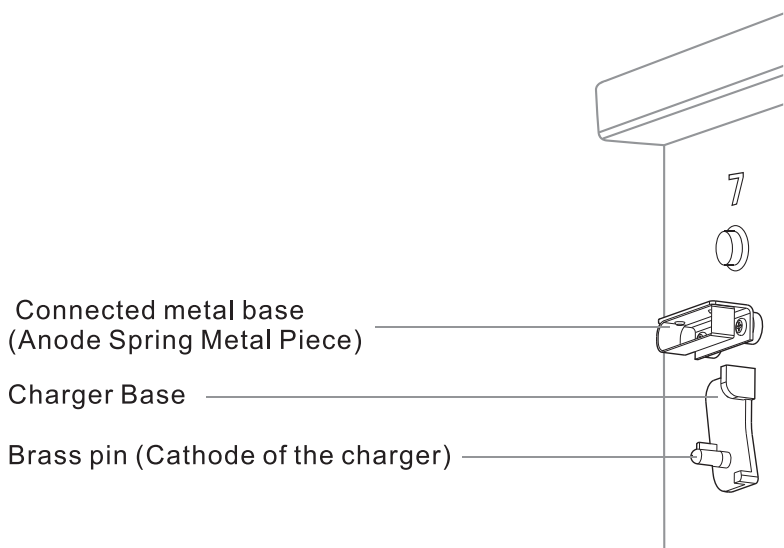

**POWER  
ON**

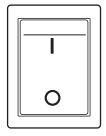

**OFF**

Power Switch

**~ INPUT AC**  
85-265V/50-60Hz

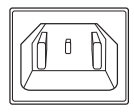

Electrical Outlet

**WISDOM®**



### NWCR-12 Li-ion battery mining lamp charger rack

Input: AC85V-265V,50-60Hz,2.0A

Output: Voltage DC4.30±0.05V

Current 3.0A ■ 2.5A ■ 2.0A ■ 1.5A ■ 1.0A ■

Unit 12Unit

Working style: continuously ID: NWCR211012626C

NEW WISDIM INVESTMENT LIMITED

<http://www.caplamp.org/> [tom@li-ion-battery.com](mailto:tom@li-ion-battery.com) Made in China

Nameplate

**WISDOM®**

#### NWCR Series Charger rack circuit

NWCR Series Charger rack circuit is workable in the world wide power ner werk, with wide inprtv voltage 85-265V,50-60Hz, work very well and reliable in the instable power net work.

NOTE:input cable cross section  $\geq 2.5\text{mm}^2$ , and well connect the charger rack with ground prtection

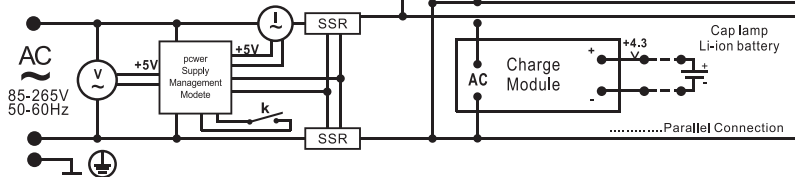

# 5 Installation instructions

Remove the carton of the outer packing.

Remove the protecting film of NWCR-24 Charging rack.

Place the charging rack to right location.

Adjust the 4 foots to keep the balance of the charger rack.

Connect AC cable into the electrical outlet and plug to the socket on the wall.

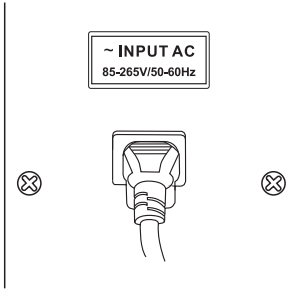

**Warning: make sure to switch off the power when connecting the AC cable!**

# 6 User Guide

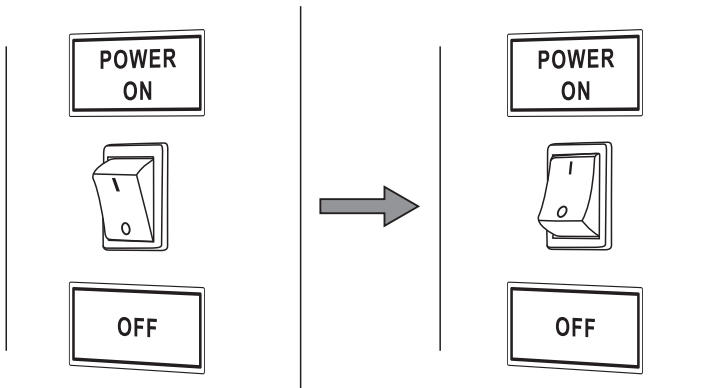

Switch the button to "ON" to launch the charging rack and supply power to AC cable. In this situation, the indicator lights of each charging port turns green.

Put the KL5M/KL8M cap lamp connected with the charger port. Fix the brass pin (cathode) of the charger to the hole of the cap lamp clip.

Rotate the cap lamp 180 degree clockwise, making sure the anode touch point of the head lamp closely connect to the connected metal base (anode spring metal piece), and then the indicator becomes red which means the lamp is in charging.

When the indicator of the charger flashes between green to red, it means the battery is at least 90% charged. The KL5M/KL8M can work for more than 14h continuously if stop charging at this moment. If the indicator of the charger flashes at green only, then the battery is fully charged.

Rotate the cap lamp 180 degree anti-clockwise; take it off from the charger.

## 7 Meaning of the Indicator Signal

Indicator signal	Meaning
Indicator off	Charger is switched off without power
Green on	Charger is in working condition without load
Red on	Charger is in working condition with load(fast charging)
Flash between green and red	Small currency charging and the battery is at least 90% charged
Flash at green	Battery is fully charged
Flash at red	Charger is out of function

## 8 Troubles and Troubleshooting

Trouble Description	Trouble analysis	Troubleshooting
Charging port's indicator inoperative	Power cable is not well connected to the power supply	Connect with the power supply again
	Charging port is damaged	Send the charger PCB back to the manufacturer for repair
Load the cap lamp on the charger, and the indicator is still in green	Bad connection between the cap lamp and the charger	Clean the connected metal base(anode spring metal piece) and the brass pin(cathode) to make sure that they can be well connected
Load the cap lamp on the charging port, and the indicator flashes at red	Charging port is out of function	Send the charger PCB back to the manufacturer for repair
Load the cap lamp on the charging port, and the indicator flashes at green	Nothing wrong, and the battery is fully charged	Take off the lamp for usage

## 9 Notes

Strictly follow the voltage range during usage.

The NWCR-24 charger rack is specially designed for the New Wisdom KL5M/ KL8M series cap lamp, hence it's better not to charge other lamps; otherwise the battery may damage.

Turn off the cap lamp when charging.

Regularly clean the connected metal base (anode spring metal piece) and the brass pin (cathode) to make sure they can be in good connection.

It's better to turn off the charger rack when the charging is finished.

# 10 Safety Warnings

Prohibited to pour water on the charger rack and use it in humid environment otherwise it will run into short circuit.

Prohibited to crash or strike the charger rack, it may cause the nut loosen and the inside circuit board damage.

It is forbidden to touch the electrical outlet while the charging rack is working, otherwise it will pose a risk of electric shock.

# 11 Package

Use carton as outer packing. size:60x25x100cm, weight:38 kg.