

# **WISDOM LAMP 4**

## **Multi-Purpose Lamp**

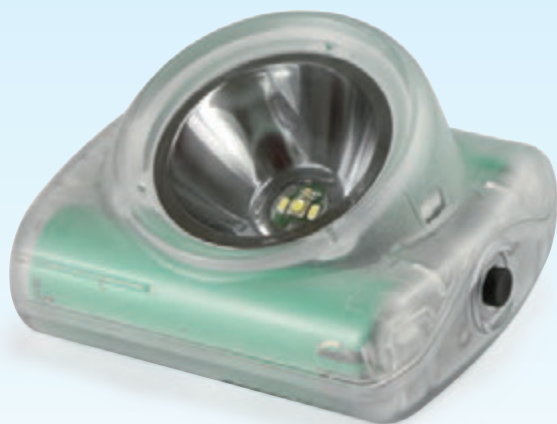

English

中文

中文

Brighter • Lighter • Power bank

# TABLE OF CONTENTS

1	FEATURES OF WISDOM LAMP 4 .....	1
2	TECHNICAL SPECIFICATION OF WISDOM LAMP 4 .....	3
3	PARTS OF WISDOM LAMP 4 .....	5
4	USER GUIDE OF WISDOM LAMP 4 .....	6
5	TROUBLE AND TROUBLESHOOTING .....	15
6	NOTES .....	15
7	SAFETY WARNINGS .....	15
8	PACKAGE .....	15

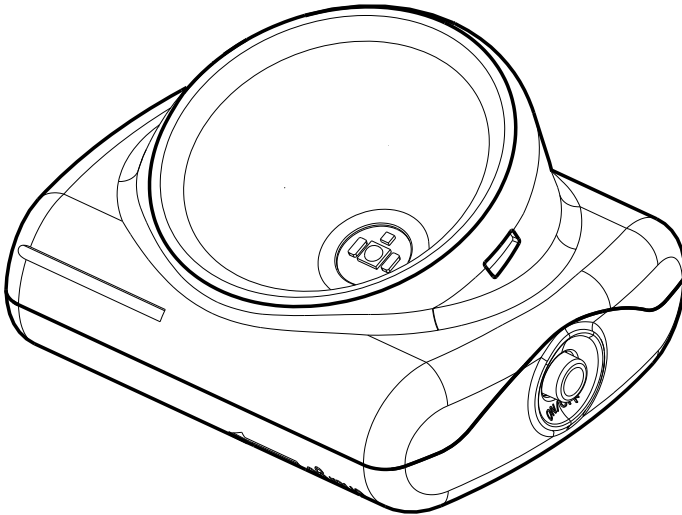



# 1 Features of WISDOM LAMP 4

The multi-purpose cordless WISDOM LAMP 4 is perfectly created with industrial design, electronic design, software design, production craft design and user-friendly design. Its unique design meets more life demands, based on WISDOM LAMP 3, WISDOM LAMP 4 achieves the software performance optimization, and the increase of mobile power bank, gear locking and SOS function, which makes it more popular in domestic lighting, outdoor activities, and many other practical purposes. The significant features are as follows:

## 1.1 100000 hours lifespan and super stable brightness

The multi-purpose cordless WISDOM LAMP 4 applies the most advanced American CREE LED light source and advanced drive PCB, which promises its life span up to 100000 hours in certain condition. The delicately designed reflector reduces the light absorption, which greatly improves the brightness.

## 1.2 Power bank

WISDOM LAMP 4 can work as a power bank through the optimized design of electronic and software working with its corresponding magnetic USB wire and adaptor, which can charge for iPhone, iPad, Android mobile phone and other equipment. It has achieved a perfect unity of lamp and power bank. As a power bank charging for mobile power, its output voltage is 5.2V. It can achieve intelligent protection, when the lamp lasts no-load for 8s, the mobile power supply can automatically disconnect. Connect the magnetic USB wire to the lamp and mobile phone and double press the button when it is off, it will enter the mode of power bank. Meanwhile, you can turn on the lamp for lighting. So it can achieve lighting while it is charging.

## 1.3 Gear lock

WISDOM LAMP 4 can achieve the selection and locking among the different brightness of main LED light source to meet the individual preferences of brightness, which has achieved customization on gear locking. It will lock the current brightness if you double press the button when it is on. And it will enter the locked brightness directly if you turn it on again, which can satisfy the users' needs better.

## 1.4 SOS function

WISDOM LAMP 4 can flash as SOS signal, when it enters the mode of SOS, which makes it possible that the users in danger can be rescued effectively. It will enter SOS mode if you press the button for 3S when it is off, and it will end SOS mode if you press the button once.

## **1.5 Multiple lenses, suitable for different scenes**

Multi-purpose WISDOM LAMP 4 adds optical lens 1, lens 2, lens 4 and lens 6 and so on to meet variety lighting way, to realize the diversified functions use.

## **1.6 Convenient charging way with USB**

Multi-purpose WISDOM LAMP 4 is designed to charge with magnetic USB wire, which makes it possible to charge the LED multi-purpose lamp with the same power adaptor with standard USB port of the general mobile phone. Meanwhile, it can also charge with the matched conventional single charger or charger rack, which is a revolutionary breakthrough in the charging way for multi-purpose lamps.

## **1.7 Super light on weight**

Multi-purpose WISDOM LAMP 4 is designed to be super light, and the lightest model 4C and 4D weighs only 128g, which is half weight of the normal lamps.

## **1.8 Battery indicator**

Multi-purpose WISDOM LAMP 4 in the standby hibernation under long by 1.5 seconds into a battery indicator status, through the weak light issued by the main light source and the secondary light source, you can identify the battery remaining capacity: >30%, >60%, >90%. Indicates 3S later, it can return to standby hibernation automatically; key short press can also exit the battery indicator status.

## **1.9 Two-stage low battery power alarms and alarm cancel**

When the main light is on, about one hour before the battery runs out and only 10 minutes lighting time, the main light will alternately alarms with dark lights warn that the battery is nearly exhausted and needs charging. If you do not want the lights flashing affect the lighting, press the switch button for more than 2 seconds, the main light flashes twice to stop the alarm and enter the normal lighting condition.

## **1.10 Many kinds of models for option**

The multi-purpose lamp of WISDOM LAMP 4 provides many kinds of models for option. There are 4A, 4B , 4C and 4D, which enables it meet different needs of users and situations.

## **1.11 Safe, reliable and maintenance-free**

The Li-ion battery of WISDOM LAMP 4 is maintenance-free. Moreover, the battery protecting PCB can protect the battery from over charge, over discharge, over current, and short circuit so

that the battery won't explode or burn. Therefore, the safety and reliability of WISDOM LAMP 4 are well guaranteed.

### 1.12 Explosion-proof and impact-resistance

The housing of WISDOM LAMP 4 is made of bulletproof PC. The optimized mold design not only strengthens the hardness of the housing but also lessens the internal stress, which makes WISDOM LAMP 4 stronger in impact resistance and more durable in life span.

### 1.13 Super waterproof

The multi-purpose WISDOM LAMP 4 applies the professionally water-proof design which enables it is approved by IP68 tested underwater 50 meters. It is made of stainless steel materials, such as, the stainless cap lamp clip and USB charging points which is made of stainless steel and gold-plated brass. Therefore, it is able to work stably under harsh working conditions.

### 1.14 Environmentally friendly

The multi-purpose lamp is designed in accordance with RoHS, which is strictly followed during the whole process, from material selection to production craft design.

## 2 Technical Specification of WISDOM LAMP 4

**2.1 WISDOM LAMP 4 is used as the mobile power bank. The parameters are as follows under power bank status.**

Features	Specification			
Model	WISDOM LAMP 4A	WISDOM LAMP 4B	WISDOM LAMP 4C	WISDOM LAMP 4D
Rated voltage	3.7V			
Rated capacity	6200mAh	4400mAh	3100mAh	2200mAh
Input voltage	5.0±10% V			
Input current	2A			
Output voltage	5.2V			
Output current	2.1A			
Special function	Input and output in the same port; WISDOM special USB adaptor wire			
Safeguard	Input counter-attack protection, output over-current protection, output over-voltage protection, output short-circuit protection, battery discharge and overcharge protection			

## 2.2 Technical Specification of WISDOM LAMP 4

Features		Specification			
Model		WISDOM LAMP 4A	WISDOM LAMP 4B	WISDOM LAMP 4C	WISDOM LAMP 4D
Rated capacity		6.2Ah	4.4Ah	3.1Ah	2.2Ah
Rated voltage		3.7V			
Main light LED Working Voltage		3.0V			
working time	Low light	60h			
	Middle light	16h			
	High light	6h			
Main light LED Working Current	Low light	65mA	50mA	50mA	40mA
	Middle light	450mA	350mA	220mA	170mA
	High light	1200mA	900mA	650mA	500mA
Main light Power	Low light	0.18W	0.14W	0.14W	0.11W
	Middle light	1.3W	1W	0.66W	0.45W
	High light	3.6W	2.7W	1.9W	1.45W
Main light Luminous flux	Low light	30Lm	23Lm	23Lm	18Lm
	Middle light	185Lm	148Lm	96Lm	75Lm
	High light	413Lm	330Lm	254Lm	203Lm
Lamp lighting degree Initial (Lighting degree in 1m)	Low light	1400Lux	900Lux	900Lux	650Lux
	Middle light	8500Lux	7000Lux	4500Lux	3000Lux
	High light	20000Lux	15500Lux	12000Lux	9000Lux
Main light life span		100000h			
Auxiliary light Power		0.4W			
Auxiliary light life span		40000h			
Short circuit protect time		<320μS			
Life span of the battery (recharges)		1200 times ( In the reasonable working conditions )			
Charging time (by NWB-30/USB)		5h	4h	4h	3h
Dimensions		84x69x50mm			
Weight		175g	175g	128g	128g

### 3 PARTS OF WISDOM LAMP 4

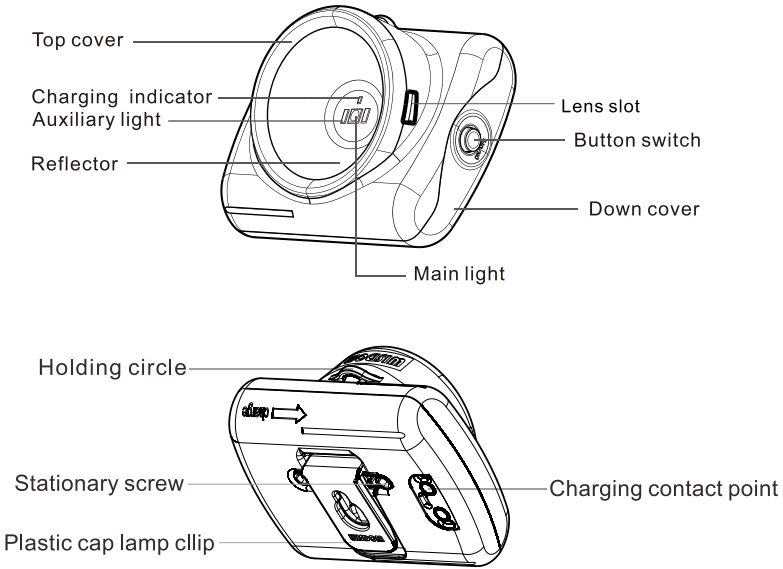

#### Standard accessories

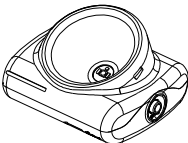

Multi-purpose lamp

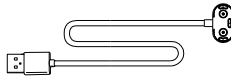

Magnetic USB wire

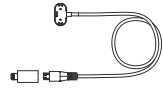

Magnetic data wire

#### Optional accessories

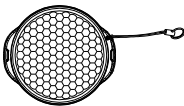

Optical lens1  
(Transparent)

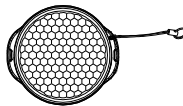

Optical lens2  
(Transparent)

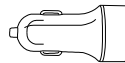

Vehicle charger adaptor



Power adaptor

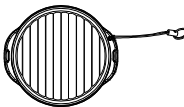

Optical lens3  
(Transparent)



Optical lens4  
(Colorful)



Head strap



Belt

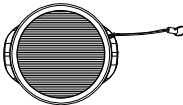

Optical lens5  
(Transparent)

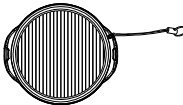

Optical lens6  
(Transparent)



Bicycle bracket



Magnetic paste



## 4 User Guide of WISDOM LAMP 4

### 4.1 Two charging ways

#### 4.1.1 USB Charging Way

Connect the “5V, 2A” power supply with magnetic USB wire to “AC, 100-240V” outlet.

The charger indicator turns green , as follows:

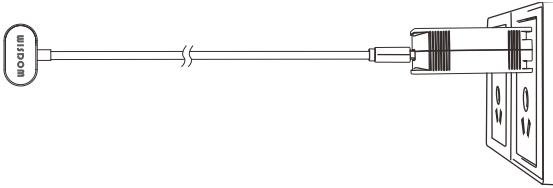

Connect the magnetic charging terminal with the USB charging points and make them contact tightly. The lamp's indicator turns red, which means it's charging.

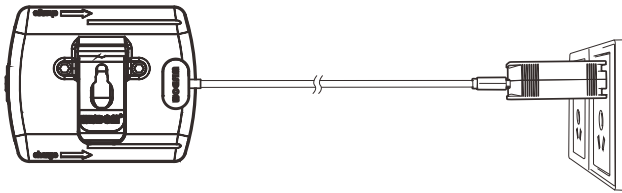

The lamp's indicator turns green, which means it is fully charged. Take away the USB wire from the lamp, and then use it normally.

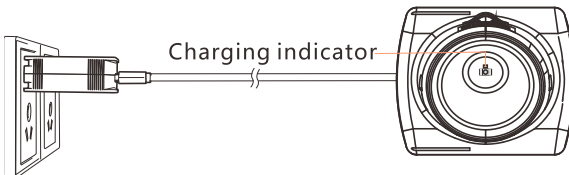

### 4.1.2 Traditional Charging Way

Connect the single charger to the power supply or switch on the charger rack, the indicator light of the charger turns green.

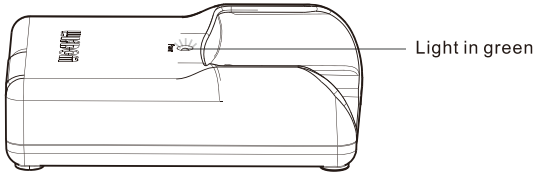

Connect the lamp with the charger. The charging indicator of cap lamp turns red.

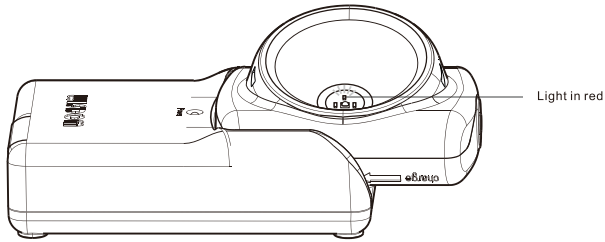
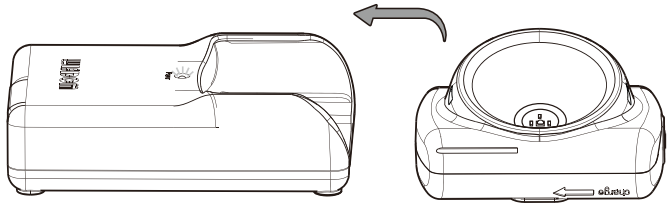

The lamp can work normally after taking the lamp away from the charger when it is in charging or finishing charging.

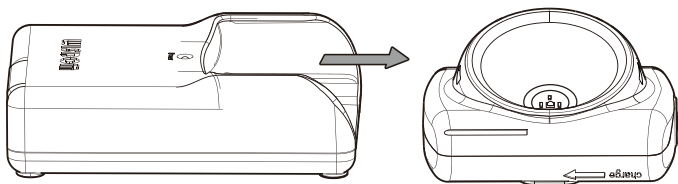
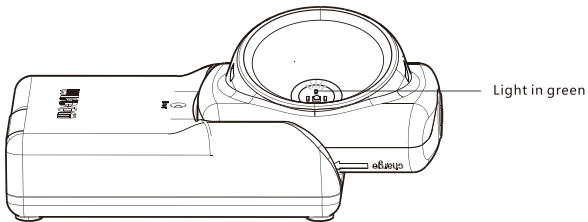

## 4.2 Charging Indication

WISDOM LAMP 4 has an indicator for the charging situation. When the indicator turns red, which means it's charging; when the indicator turns green, which means it is fully charged. During the progress of charging, the soft lighting of the main and auxiliary light source can indicate the charging situation.

After the lamp completes the charging, the indicator turns green from red, and the main and auxiliary light source are both off.

All the indicators are as follows:

Charging stage	Status of charging indicator
Battery capacity $\leq 1/3$	
1/3 < Battery capacity $\leq 2/3$	
Battery capacity > 2/3	
Fully charged	

**Note:** The cap lamp battery indications just a general one, just for your reference.

## 4.3 Switch

### 4.3.1 General lighting mode

Pressing the switch button once when the light is off, it will be into low light mode; pressing second, it will be into middle light mode; pressing third, it will be into high light mode. The details are as follows:

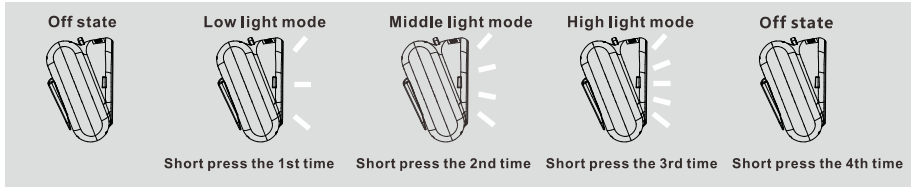

### 4.3.2 Customized locking mode

Pressing the button double shortly ( within 3s ) when the light is on, it will lock the current brightness mode. Pressing double again, it will unlock the brightness mode. The details are as follows:

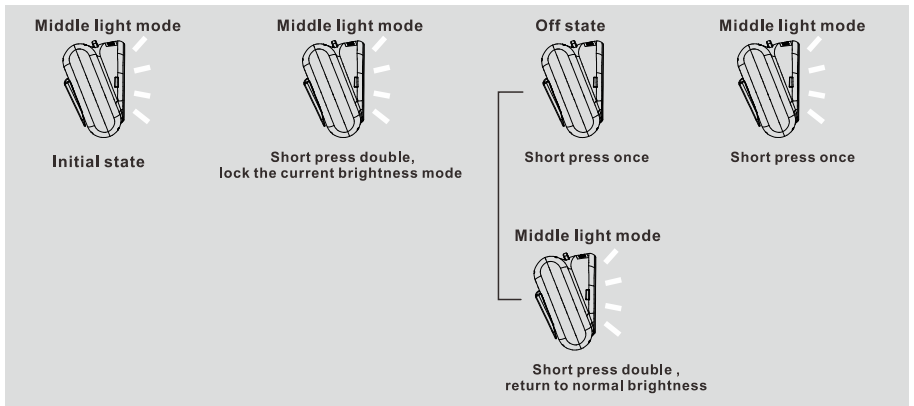

### 4.3.3 Charging bank mode

Pressing the button double shortly (within 3s ) when the light is off, it will be into charging bank mode. At this time, you can charge for your mobile phone or other equipment. Meanwhile, you can also turn it on for lighting when it is charging for the mobile phone. The details are as follows:

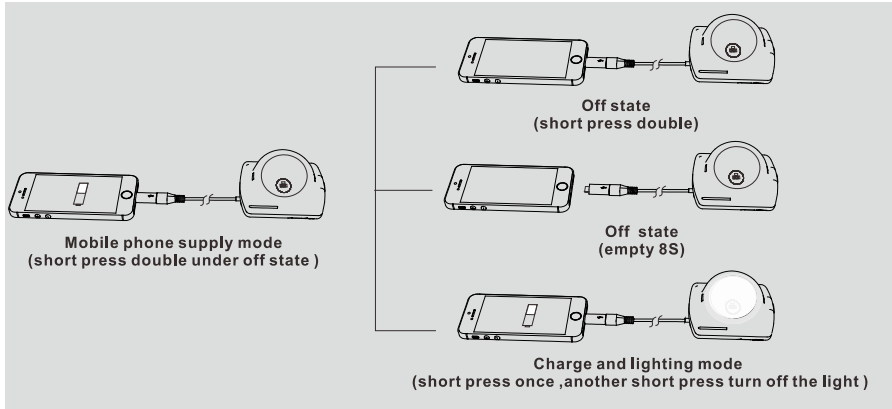

### 4.3.4 SOS mode

Pressing the button for 3s when the light is off, it will be into SOS mode by the regular flashing with 3 times short and long flashing .The details are as follows.

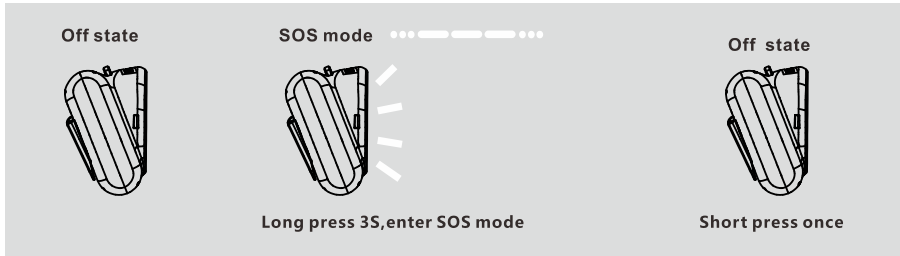

### 4.3.5 Battery indicator

Pressing the button for more than 1.5 seconds when the light is off, it will be into the battery power indicator status. The main light source and two auxiliary light sources flash a low light as the battery power status instructions.

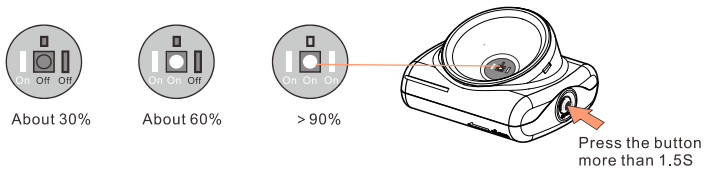

The battery power indicator is on for 3 seconds before off.

**Note: The above status instructions are just for your reference.**

## 4.4 Two-stage low battery alarms and alarm cancel

About 1 hour before the battery power is out, the main LED light of WISDOM LAMP flashes softly (one time flashing for every 5 seconds) to remind the user that the power is nearly used up and needs to be recharged. If you don't want the flashing to affect the normal lighting, you can press the switch more than 2 seconds. The main light source will flash twice, and the flashing is away. Then the cap lamp restores to normal working.

When the battery is only able to keep the cap lamp on for 10 minutes, its main light source will flash with the strong and soft light quickly (flashing once for every 2 seconds). This information is to remind you that the battery is nearly used up and it needs recharging or exchanging to the Low light model.

## 4.5 Practical lens for civil using

**Lenses 1, 2, 6, 4 of WISDOM LAMP 4 are able to satisfy the practical civil using.**

**The lens assembly way:**

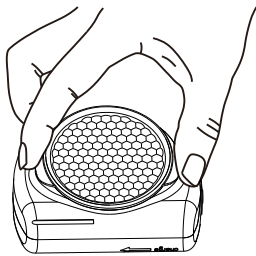

Picture 1  
(installing operation)

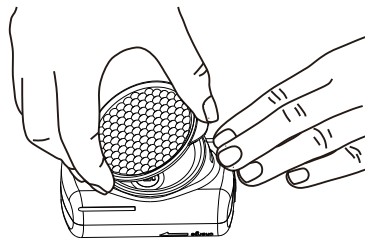

Picture 2  
(removing operation)

### 4.5.1 Optical lens 1

Put the lens 1 into the slot of cap lamp, which can change the original strong light into wider range of soft light. So WISDOM LAMP with lens 1 is a kind of ideal lighting equipment for outdoor camping.

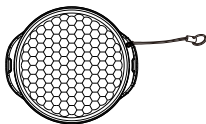

Optical lens 1

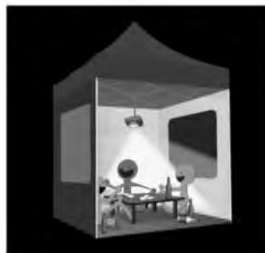

Lighting without WISDOM lens



Lighting with WISDOM lens 1

### 4.5.2 Optical lens 2

Put the optical lens 2 into the slot of cap lamp, which can change the original strong light into narrower range of soft light. So WISDOM LAMP with optical lens 2 is a kind of ideal lighting equipment for night reading.

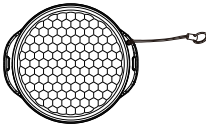

Optical lens 2

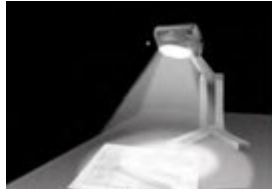

Lighting without WISDOM lens

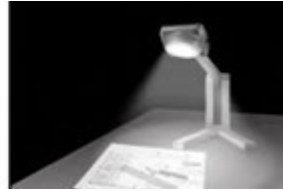

Lighting with WISDOM lens 2

### 4.5.3 Optical lens 3\5\6

The optical lens 3\5\6 is specially designed for the lighting of the bicycle. Put them into the slot of cap lamp, which can widen the point-light into a widely visible range. So it is a kind of ideal lighting equipment for night riding.

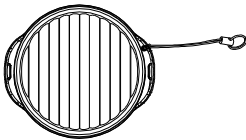

Optical lens 3



Lighting without WISDOM lens



Lighting with WISDOM lens 3

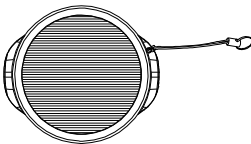

Optical lens 5



Lighting without WISDOM lens



Lighting with WISDOM lens 5

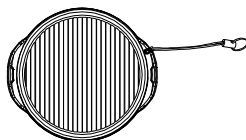

Optical lens 6



Lighting without WISDOM lens



Lighting with WISDOM lens 6

#### 4.5.4 Optical lens 4

Put the optical lens 4 into the lens slot of multi-purpose lamp, which can change the originally simple light into colorful light. So WISDOM LAMP with optical lens 4 is ideal lighting equipment for night warning, for fun and so on.



**Optical lens 4**  
(Colorful)

#### 4.6 Fix the lamp

You can not only fix WISDOM LAMP 3 on the cap but also on the wall with a nail..

#### 4.7 Hold the lamp by the belt

You can use the belt to hold WISDOM LAMP for more convenient usage. There are one way as following :

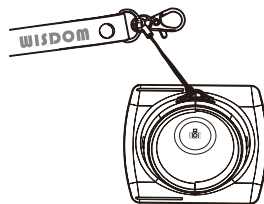

hold with the hole

#### 4.8 WISDOM LAMP 4 bicycle bracket parts

WISDOM LAMP 4 multipurpose lamp can choose bicycle bracket, for the cyclists, and it can make the multi-purpose light tightly fixed on the handle of the bicycle. WISDOM LAMP 4 can be used as a bicycle lamp, increase the function multimode of the four generation lamp fixed use .The installation diagram as follows:

**Step one:** prepare for bicycle bracket and matched fastening coil.

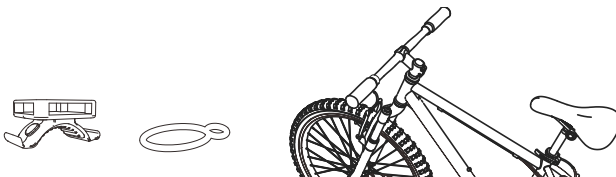



**Step two:** one end of the fastening coil is buckled on the bicycle bracket, the other end is pinched and around on the bicycle handle.

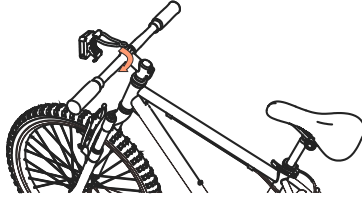

**Step three:** fastening coil which bypassed the bicycle handle at one end buckles bicycle's other end, the mounting bracket is completed.

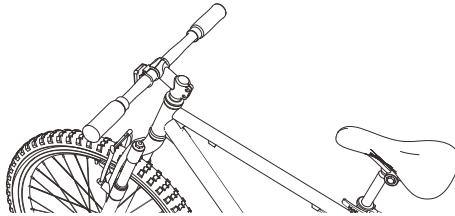

**Step four:** plastic cap clip WISDOM LAMP 4 card into a bicycle bracket.

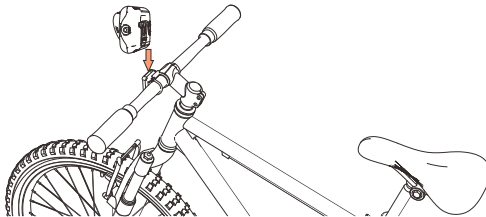

**Step five:** the installation is completed.

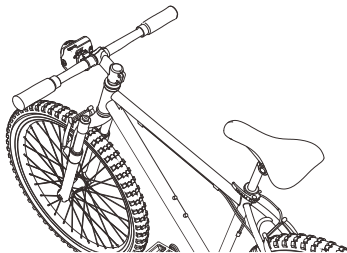

## 5 Trouble and troubleshooting

Trouble description	Trouble analysis	Troubleshooting
Light is not on when pressing the button	1. Battery power is used up or the circuit board is being protected 2. Lamp is damaged	1. Charge the lamp 2. Send back to the dealer for repairing
Working time is inconsistent with specifications	Battery is not fully charged	Make sure the lamp well connected to the charger when charging
Longer charging time	The charging points poor contact	Clean the charging points and the slot

## 6 Notes

- Please put wisdom lamp4 in non-potentially explosive environment when using to ensure the safety.
- WISDOM LAMP4 is half charged before delivery, please fully charge it before using.
- Please use our own matched charger/charging rack or magnetic USB wire to charge the multi-purpose lamps, or the lamp may be damaged.
- If the lamps need storing for a long period, please repeat the following maintenance steps every two months: Fully charged →completely discharged →charged for 2 hours.
- Please clean up the dust in the charging point slot timely for the normal charging with the USB wire.
- Please keep it clean and take care of the magnetic USB wire and power supply for its normal use of mobile power bank.

## 7 Safety warnings

- Please don't shoot at eyes directly while the lamp is working since the strong light will hurt eyes.
- Please don't disassemble the cap lamp, or it may cause potential troubles related to safety, reliability to work underground.
- Please don't crash and strike the lamp.
- Please keep the lamp away from fire sources.
- Please recycle the discarded cap lamp together rather than throwing them away without disposing

## 8 Package

- The WISDOM LAMP 4 is packed by blister package which is 175 x 105 x 70 mm.
- The outer box is packed by carton package which is 38 x 22.5x 44 mm containing 24 pieces of WISDOM LAMP 4.

# WISDOM

Telephone: +86-755-83911841

Mailbox: [info@wisdom.hk](mailto:info@wisdom.hk)

Address: 4-306, Xianglixincuen, Hongli West Road, Shenzhen, China

[www.wisdom.hk](http://www.wisdom.hk)

Zip code: 518034

# 目录

1 WISDOM LAMP 4 多用途灯特性.....	1
2 WISDOM LAMP 4 多用途灯技术参数 .....	3
3 WISDOM LAMP 4 多用途灯结构组件 .....	5
4 WISDOM LAMP 4 多用途灯使用说明 .....	6
5 故障与检修.....	16
6 注意事项 .....	16
7 安全警示 .....	16
8 包装规格 .....	16

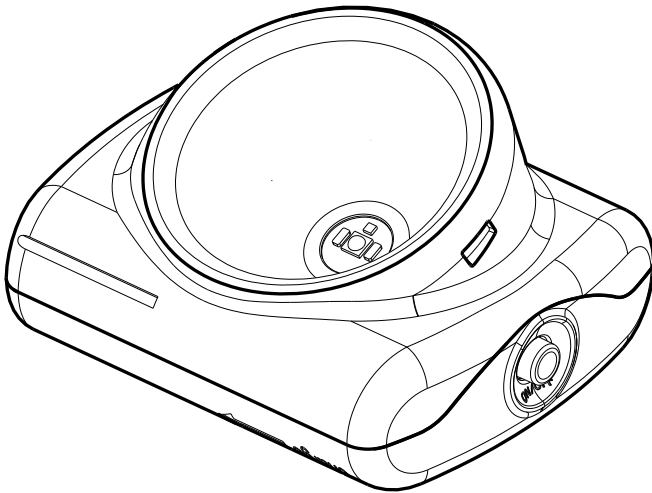



# 1 WISDOM LAMP 4 多用途灯特性

创新设计的 WISDOM LAMP 4 无绳多用途灯是经过精心的工业设计、电子设计、软件设计和生产工艺设计的结晶。WISDOM LAMP4 独特的设计满足了更多的生活需求，在 WISDOM LAMP 3 的基础上实现软件性能最大化，并增加了移动电源，档位锁定以及 SOS 功能，使其在家用照明、户外活动、自行车夜间照明等领域更受欢迎。显著特性如下：

## 1.1 十万小时寿命以及稳定的超高亮度

WISDOM LAMP 4 多用途灯采用了最先进的美国 CREE LED 光源和先进的驱动电路，在一定条件下主光源有 100000 小时的寿命。精心设计的反光杯有效减少光的吸收，以优化和提高光效，使得多用途灯保持稳定的高亮度和长寿命。

## 1.2 移动电源功能

WISDOM LAMP 4 通过电子和软件的最优设计实现了移动电源功能，与其配套设计出的磁力充电线，转接头的配合使用可以给 iPhone, iPad, Android 手机等设备充电，实现了灯与移动电源功能的完美统一。作为移动电源给手机充电时，输出电压为 5.2V，给手机充电；手机断开空载 8S 超时，移动电源能够自行断开，实现智能保护作用。在休眠状态下双击开关按钮即可进入移动电源模式，接上磁力充电线即可给手机充电，与此同时还可亮灯使用，实现充电、亮灯两不误。

## 1.3 档位锁定

WISDOM LAMP 4 为满足个人喜好亮度而定制出档位锁定功能，可在主光源的不同亮度间进行选择 and 锁定。在亮灯状态下，双击开关按钮即可锁定当前亮度，再次开启可直接进入锁定亮度下的工作模式，使之更为贴合用户需求。

## 1.4 SOS 功能

WISDOM LAMP 4 在 SOS 功能模式下，主光源会以 SOS 的信号时序进行闪灯，实现求救功能，使处于危险状况下的用户得到救援的可能。在待机休眠状态，长按开关 3 秒即可进入 SOS 模式，短按开关即可退出。

## 1.5 多种光学镜片，适用不同的场景

WISDOM LAMP 4 多用途灯根据生活中的实际用途增加了光学镜片 1，光学镜片 2，光学镜片 4，光学镜片 6 等以满足生活中多种照明方式，实现功能多样化使用。

## 1.6 支持磁力 USB 充电方式

WISDOM LAMP4 多用途灯设计、制造出磁力 USB 充电线，使用通用型 USB 充电电源就能给多用途灯充电，也可选用兼容配套的专用充电器或充电架充电，是多用途灯充电易用性的一个革命性突破。

## 1.7 重量超轻

WISDOM LAMP 4 多用途灯采用超轻量级的设计，4C 和 4D 仅为 128g，远远轻于一般的头灯。

## 1.8 电池电量指示

WISDOM LAMP 4 多用途灯在待机休眠状态下长按 1.5 秒可进入电池电量指示状态，通过主光源和副光源发出的弱光可以直观的识别电池剩余电量: >30%，>60%，>90%。指示 3 秒后，自动回到待机休眠状态；按键短按也可退出电量指示状态。

## 1.9 两阶段低电量告警和告警取消

在主光源点亮的状态，电池电量耗尽前约 1 小时和仅足以维持照明 10 分钟左右的时候，其主光源会有规律明暗交替闪烁用于提示电池电量快耗尽了，需要重新充电。如果不希望灯光不停闪烁而影响照明，可以按下开关按钮 2 秒以上，主光源会在闪烁两次后停止告警提示，并进入正常照明状态。

## 1.10 多种型号可选

WISDOM LAMP 4 多用途灯有 4A，4B，4C，4D 四种型号可供选择。它满足了不同用户和场合的需求。

## 1.11 安全可靠，免维护

本多用途灯所采用的锂电池具有免维护的特性。电池组的保护电路具有输入防反，输出过流，输出过压，输出短路护，电池过充过放等问题的多重保护功能，保证电池不会因过充过放、温度过高、短路、撞击而产生爆炸或燃烧，从而确保多用途灯使用的安全。

## 1.12 防爆壳超级耐冲击

WISDOM LAMP 4 多用途灯的壳体使用防弹级 PC 材料制成。优化设计的模型不仅保证了壳体的强度并且减小了内应力，这使得 WISDOM LAMP 4 拥有更强的耐冲击力和更经久耐用。

### 1.13 超强防水功能

WISDOM LAMP 4 多用途灯采用了专业防水设计,通过了 50 米水深的 IP68 测试。各个部件都采用了不锈钢材料,如帽钩采用了塑胶材料,USB 充电接触点采用了不锈钢和镀金的黄铜材料,以保证多用途灯卓越的防水能力使其能够在苛刻的环境下不生锈且长时间稳定工作。

### 1.14 对环境无害

WISDOM LAMP 4 多用途灯的设计完全遵守《有害物质限制指令》(RoHS)。有害物质限制指令的执行贯穿于整个生产流程,从原材料的挑选到制造工艺的设计都严格遵照该指令。

## 2 WISDOM LAMP 4 多用途灯技术参数

### 2.1 WISDOM LAMP 4 作为移动电源使用时,其参数如下:

特性	技术规格			
型号	WISDOM LAMP 4A	WISDOM LAMP 4B	WISDOM LAMP 4C	WISDOM LAMP 4D
电池额定电压	3.7V			
电池容量	6200mAh	4400mAh	3100mAh	2200mAh
输入电压	5.0±10% V			
输入电流	2A			
输出电压	5.2V			
输出电流	2.1A			
特殊功能	输入输出在同一端口;WISDOM 专用 USB 转接线			
安全保护	输入防反保护,输出过流保护,输出过压保护,输出短路保护,电池过充过放保护			



## 2.2 WISDOM LAMP 4 灯的技术参数如下：

特性		技术规格			
型号		WISDOM LAMP 4A	WISDOM LAMP 4B	WISDOM LAMP 4C	WISDOM LAMP 4D
额定容量		6.2Ah	4.4Ah	3.1Ah	2.2Ah
额定电压		3.7V			
LED 主光源工作电压		3.0V			
放电时间	低亮模式	60h			
	中亮模式	16h			
	高亮模式	6h			
LED 主光源工作电流	低亮模式	65mA	50mA	50mA	40mA
	中亮模式	450mA	350mA	220mA	170mA
	高亮模式	1200mA	900mA	650mA	500mA
主光源功率	低亮模式	0.18W	0.14W	0.14W	0.11W
	中亮模式	1.3W	1W	0.66W	0.45W
	高亮模式	3.6W	2.7W	1.9W	1.45W
主光源光通量	低亮模式	30Lm	23Lm	23Lm	18Lm
	中亮模式	185Lm	148Lm	96Lm	75Lm
	高亮模式	413Lm	330Lm	254Lm	203Lm
灯亮度(初始亮度)一米的距离	低亮模式	1400Lux	900Lux	900Lux	650Lux
	中亮模式	8500Lux	7000Lux	4500Lux	3000Lux
	高亮模式	20000Lux	15500Lux	12000Lux	9000Lux
主光源工作寿命		100000h			
副光源功率		0.4W			
副光源工作寿命		40000h			
短路保护时间		<320 $\mu$ S			
电池工作寿命(重复充电)		1200 次 (在合理的工作条件下)			
充电时间(用 NWB-30) USB		5h	4h	4h	3h
尺寸		84x69x50mm			
重量		175g	175g	128g	128g

### 3 WISDOM LAMP 4 多用途灯结构组件

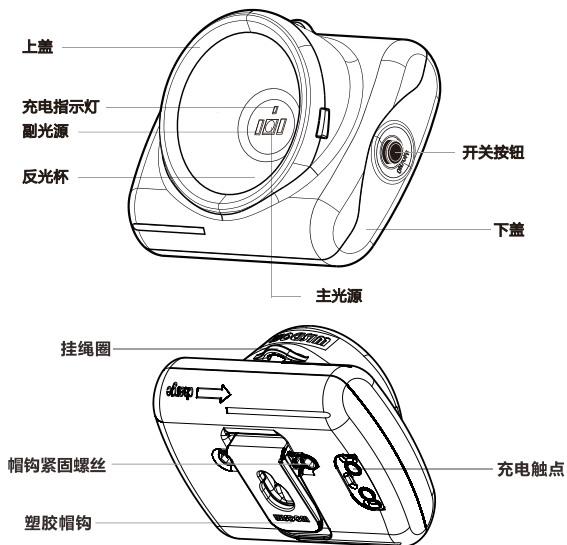

#### 标配

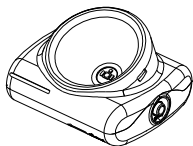

灯

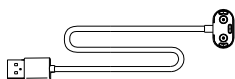

磁力 USB 充电

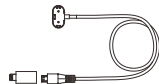

磁力数据线

#### 选配

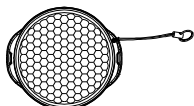

光学镜片 1(透明)

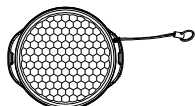

光学镜片 2(透明)

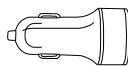

车充适配器



电源适配器

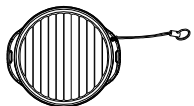

光学镜片 3(透明)



光学镜片 4(彩色)

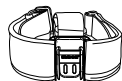

头绳



挂绳

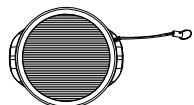

光学镜片 5(透明)



光学镜片 6(透明)



自行车支架



磁力贴

## 4 WISDOM LAMP 4 多用途灯使用说明

### 4.1 两种充电方式充电

#### 4.1.1 USB 充电方式

将“5V 2A”电源适配器接上磁力 USB 充电线并插入“AC,100-240V”的插座，充电器的指示灯为绿色。（如下图）

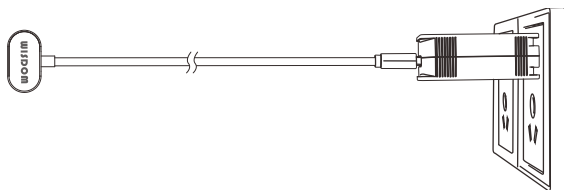

将磁力充电头端子接于多用途灯的 USB 充电点，确保磁力头的触点和 USB 充电点位紧密接触。

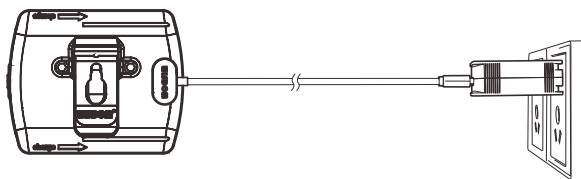

当多用途灯充电指示灯为红色时表示正在充电，变成绿色时表示电池已经完全充满。此时可取下磁力 USB 充电线正常使用多用途灯。

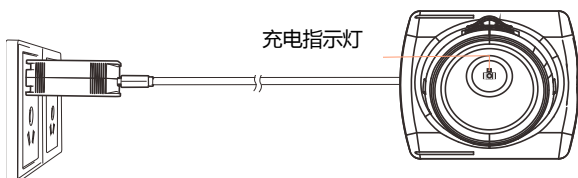

## 4.1.2 传统充电方式

将便携式充电器接上电源，便携式充电器的绿色指示灯会点亮。

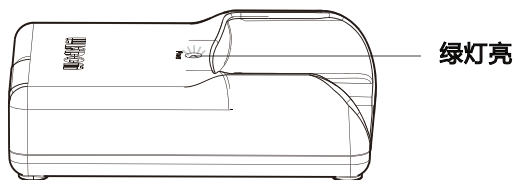

将多用途灯按图示的方向插入充电器中，多用途灯里的充电指示灯会变红。

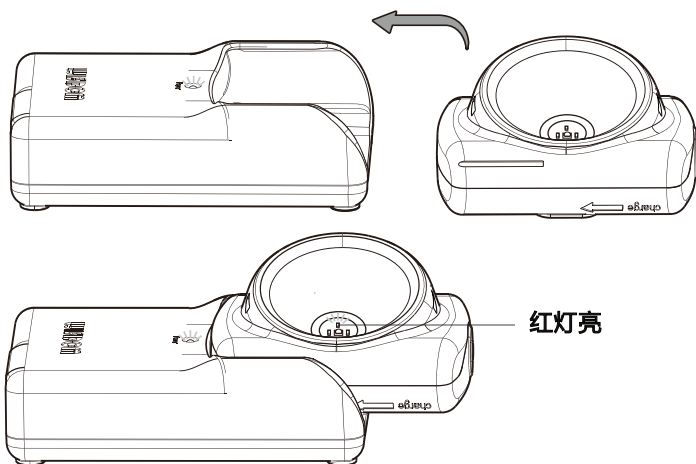

在多功能灯充电过程中，或多用途灯电池充满后，把多用途灯从充电器中拔出，即可正常使用多用途灯。

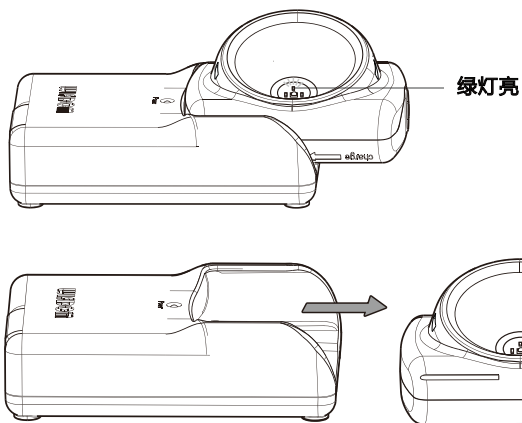

## 4.2 充电指示功能

WISDOM LAMP 4 多用途灯有专门的充电状态指示灯。充电指示灯为红色时表示正在充电；充电指示灯为绿色时表示电池已经充满。在充电的过程中，主光源和两个副光源会发出弱光，作为充电进程指示。

待多用途灯电池完全充满后，充电指示灯会由红色变为绿色，主、副光源都熄灭。

在多用途灯充电的过程中各指示灯的指示方式如下：

充电阶段	指示灯状态
电池电量 $\leq 1/3$ 满	
$1/3$ 满 < 电池电量 $\leq 2/3$ 满	
电池电量 $> 2/3$ 满	
电池完全充满	

**注意：**多用途灯的充电进程指示只是一个大概的指示，仅供参考。

## 4.3 开、关灯

### 4.3.1 普通照明模式

在熄灭的状态下，按下开关即可打开低亮度灯光模式，再次按下开关即可进入中亮度灯光模式，在中亮度模式下按下开关进入高亮度灯光模式，具体图示如下：



### 4.3.2 个性化(锁定)模式

在亮灯状态下，短按两次（0.3s 内）开关即可锁定当前亮度模式，短按两次可解锁，具体图示如下：

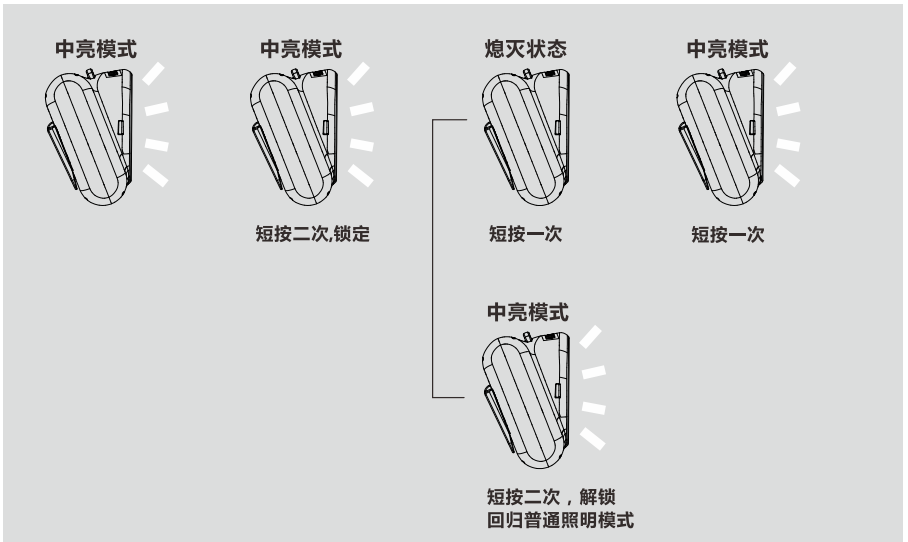

### 4.3.3 移动电源模式

在熄灭状态下，短按两次（0.3s 内）开关即可进入移动电源模式，此时可以给手机等设备充电，同时还可兼用中光照明功能，具体图示如下：

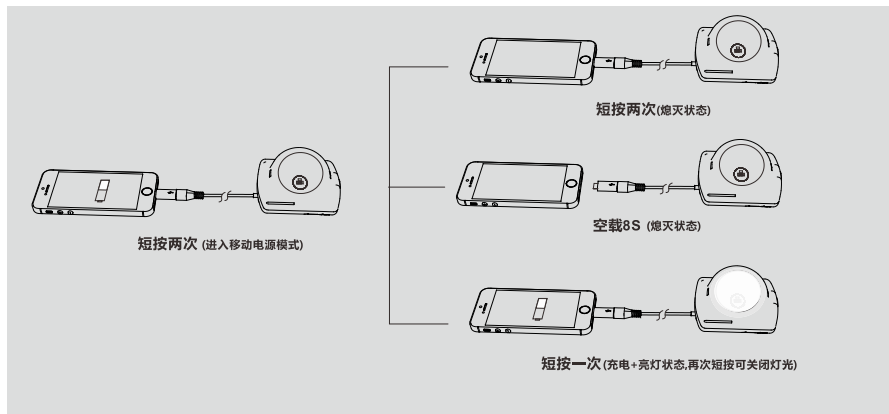

### 4.3.4 SOS 模式

在熄灭状态下，长按开关 3 秒，即可进入 SOS 模式，通过灯光三短三长的频闪实现 SOS 功能，具体图示如下：



### 4.3.5 电量指示模式

在熄灭状态下，长按开关 1.5 秒，即可进入电量指示状态，通过主光源和副光源发出的弱光可以直观的判断电池电量的多少，具体图示如下：

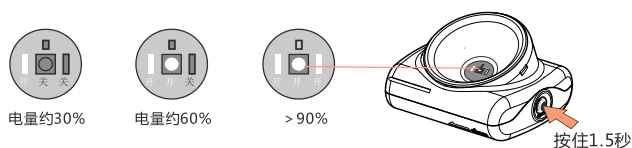

电量显示 3 秒钟后，多用途灯恢复到熄灭状态。

**注意：**WISDOM LAMP 4 多用途灯的电量指示只是一个大概的指示，仅供参考。

## 4.4 两阶段低电量告警和告警取消

在主光源点亮的状态，电池电量耗尽前约 1 小时，主光源会有规律明暗交替闪烁（每 5 秒闪烁一次），用于提示电池电量快耗尽了，需要重新充电。如果不希望灯光不停闪烁而影响照明，可以按下开关按钮 2 秒以上，主光源会在闪烁两次后停止告警提示，并进入正常照明状态。

在电池电量仅足以维持照明 10 分钟左右的时候，主光源会有规律明暗交替快闪（每 2 秒闪烁一次）告警，提示电池电量马上就要耗尽了，需要马上充电或切换到低亮模式。

## 4.5 WISDOM LAMP 4 光学镜片配件

WISDOM LAMP4 提供多种光学镜片配件,可变换照射模式,增强了多用途灯的实用性.  
镜头装拆示意图：

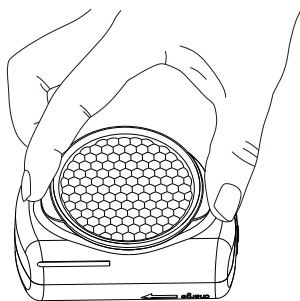

图一（安装动作）

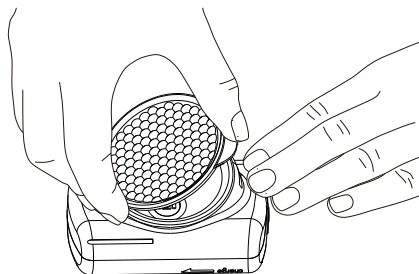

图二（拆卸动作）



### 4.5.1 光学镜片 1

把光学镜片 1 卡于多用途灯的镜片卡槽处,即将原来的多用途灯的强光变成大范围的柔光,是出外露营的不错的照明灯具。



光学镜片 1  
(透明)



未使用光学镜片



使用光学镜片 1

### 4.5.2 光学镜片 2

把光学镜片 2 卡于多用途灯的镜片卡槽处,即将原来的多用途灯的强光变成小范围的柔光,是夜晚看书写字理想的台灯。

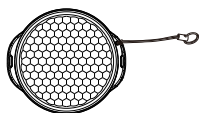

光学镜片 2  
(透明)



未使用光学镜片



使用光学镜片 2

### 4.5.3 光学镜片 3\5\6

光学镜片 3\5\6 是专门为自行车设计的一款照明配件,将其卡于多用途灯的镜片卡槽处,可以将点光源的强光拓展到宽阔的可视范围,非常适合骑自行车夜间照明。



光学镜片 3  
(透明)



未使用光学镜片



使用光学镜片 3

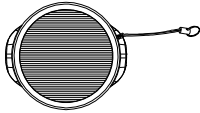

光学镜片 5  
(透明)



未使用光学镜片



使用光学镜片 5



光学镜片 6  
(透明)



未使用光学镜片



使用光学镜片 6

#### 4.5.4 光学镜片 4

将光学镜片 4 装在多用途灯上时,可使原白光变成多种颜色的光,非常适合夜间警示、求救及娱乐等。



光学镜片 4  
(彩色)

#### 4.6 固定在墙上使用

WISDOM LAMP 4 无绳多用途灯利用帽钩的 独特设计,还可以利用钉子挂在墙上使用。

#### 4.7 挂绳方式

WISDOM LAMP 4 无绳多用途灯可以选配挂绳,作为便携式照明使用。多用途灯挂绳的方式如下:

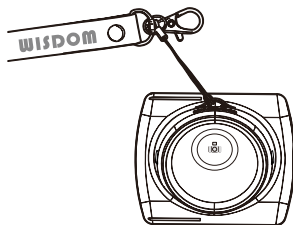

## 4.8 WISDOM LAMP 4 自行车支架配件

WISDOM LAMP 4 多用途灯可选配自行车支架，转为自行车一族设计，它能让多用途灯紧密固定于自行车把上，让 WISDOM LAMP 4 能够作为自行车灯来使用，增加四代灯的多方式固定使用的功能。其安装示意图如下：

步骤一：准备好自行车支架与配套的紧固线圈。

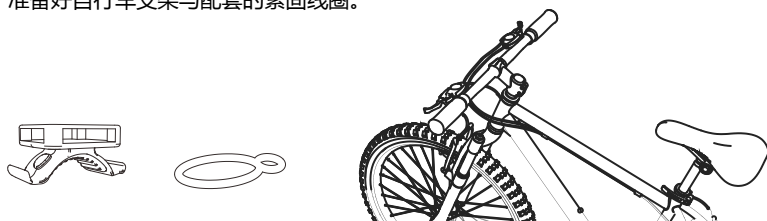

步骤二：将紧固线圈一端扣于自行车支架上，另一端用手捏住并绕在自行车把手上。

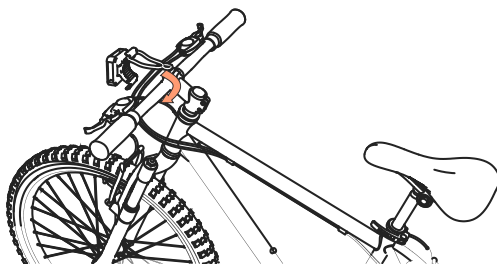

步骤三：将绕过自行车把手一端的紧固线圈扣住自行车支架的另一头，安装支架完成。

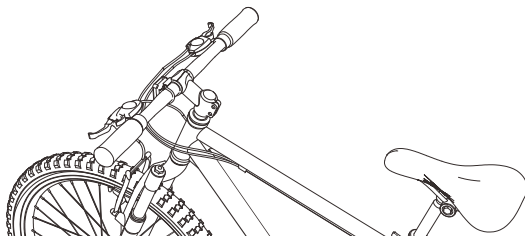

步骤四：将 WISDOM LAMP 4 的塑胶帽钩卡入自行车支架中。

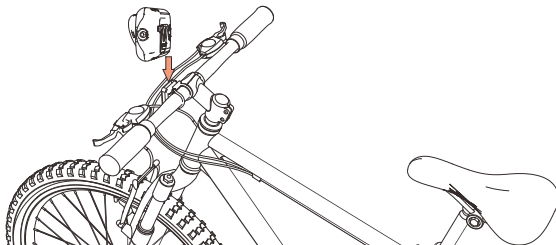

步骤五：安装完成。

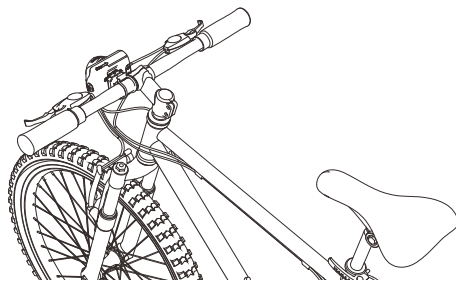

## 5 故障与检修

故障描述	故障分析	处理方法
按键不能开灯	1、电池电量耗尽或保护 2、坏了	1、将多用途灯接到充电器上充电 2、返厂维修
放电时间不符参数规格	电池没充满电	充电时确保多用途灯和充电器的良好接触
充满的时间越来越长	充电接触点接触不良	清洁充电点及限位槽内的污垢

## 6 注意事项

- 为了确保 WISDOM LAMP4 的使用安全，请在非潜在爆炸性环境中使用。
- WISDOM LAMP 4 无绳多用途灯出厂前已经充电至半饱，使用前应先用充电器对多用途灯充电至充满。
- 请采用本产品配套的充电器或充电架进行充电，若使用其他类型充电器充电会损坏多用途灯。
- 长时间不用时，每隔两个月按照以下步骤进行一次维护：完全充电→完全放电→2 小时充电的维护操作。
- 为了确保 USB 的充电功能正常，请及时清洁 USB 充电点限位槽里的污垢。
- 为了确保移动电源功能正常使用，请妥善保管好磁力充电线和转接头，并注意清洁。

## 7 安全警示

- 多用途灯在工作时不能直接对人眼睛照射，否则强光会损伤人的视力。
- 严禁随意拆卸多用途灯的零部件，严禁在危险场所使用缺少零件的多用途灯，否则会影响安全性及可靠性。
- 严禁摔打多用途灯。
- 严禁将多用途灯靠近或投入火源中。
- 报废多用途灯应集中处理，不得随意丢弃。

## 8 包装规格

- 多用途灯配件采用 WISDOM LAMP 4 彩盒包装，彩盒尺寸为：175 x 105 x 70 毫米。
- 每 24 个无绳灯采用纸箱包装，纸箱外形尺寸为：38 x 22.5x 44 厘米。

# WISDOM

电话 : 0755-28990261

邮箱 : [info@wisdom.hk](mailto:info@wisdom.hk)

工厂地址 : 深圳市龙岗区龙城街道嶂背路9号1、4楼

[www.wisdom.hk](http://www.wisdom.hk)

邮编 : 518172

## Reasons to choose **WISDOM** multi-purpose lamp

- ( 1 ) Power bank
- ( 2 ) Stable and super bright
- ( 3 ) Small size,light weight and portable design
- ( 4 ) A variety of lenses for different lighting purposes
- ( 5 ) Magnetic USB wire charging
- ( 6 ) Adjustable lighting angle
- ( 7 ) Safe, reliable and maintenance-free
- ( 8 ) More options of different models
- ( 9 ) Explosion-proof and super impact-resistance
- (10) Super waterproof
- (11) Environmentally-friendly
- (12) Longer life span



Telephone : +86-755-83911841

Mailbox : info@wisdom.hk

Address: 4-306, xianglixincuen, Hongli West Road, shenzhen, China

[www.wisdom.hk](http://www.wisdom.hk)

Zip code: 518034