

Outdoor/Night fishing/Hunting/Building/Home
WISDOM LAMP 3
Lighter/Brighter/High efficient

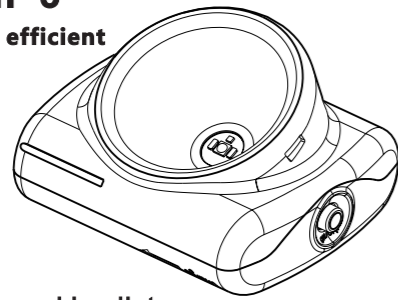

1. WISDOM LAMP 3 packing list

1.1 Standard accessories



Multi-purpose lamp



Magnetic USB wire

1.2 Optional accessories

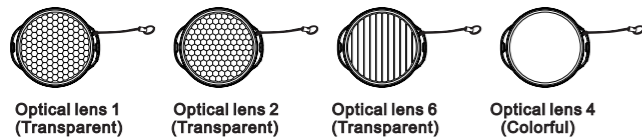

Optical lens 1 (Transparent) Optical lens 2 (Transparent) Optical lens 6 (Transparent) Optical lens 4 (Colorful)



Power adaptor Vehicle charger adaptor Belt Head strap Bicycle frame

2. WISDOM LAMP 3 structural components

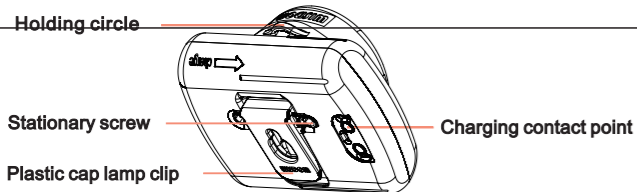
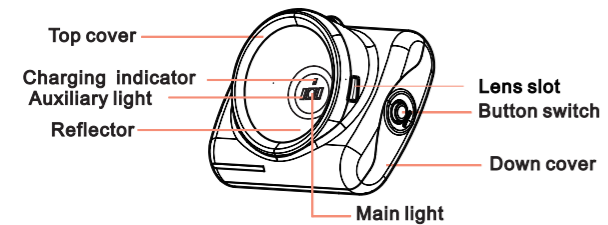

3. User Guide of WISDOM LAMP 3

3.1 USB Charging Way

3.1.1 Connect the "5V, 2A" power supply with magnetic USB line to "AC, 100-240V" outlet. The charger indicator turns green, as following:

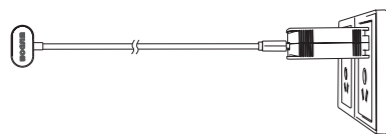

3.1.2 Connect the magnetic charging terminal with the USB charging points, make them contact tightly. The lamp's indicator turns red, which means it's charging.

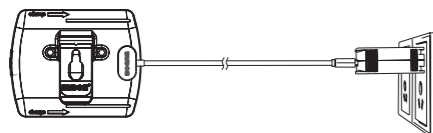

3.1.3 The lamp's indicator turns green, which means it is fully charged. Take away the USB line from the lamp, and then use it normally.

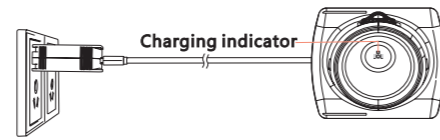

3.2 Charging stage indication

Charging stage indication is shown as below while charging:

Charging stage	Status of charging indicator
Battery capacity ≤ 1/3	
1/3 < Battery capacity ≤ 2/3	
Battery capacity > 2/3	
Fully charged	

3.3 Switch

3.3.1 General lighting mode

Press the switch button once, it will enter low-light mode, pressing second, it will enter middle light mode, pressing third on the middle light, it will enter high light mode. The details are showed as following:

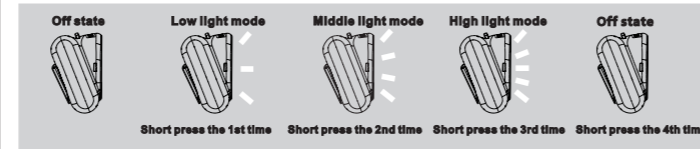

3.3.2 Customized locking mode

Press the button double shortly (within 3s) when it is on, it will lock the current brightness gear. Press double again, it will unlock the brightness gear. The details are showed as following:

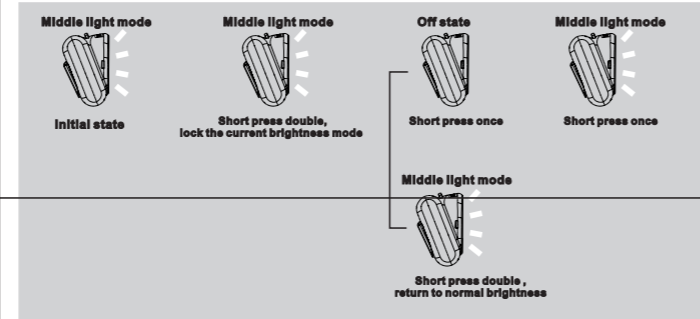

3.3.4 SOS mode

Press the button for 3s when it is off, it will enter SOS mode by the regular flashing with 3 times short and long flashing. The details are showed as following.

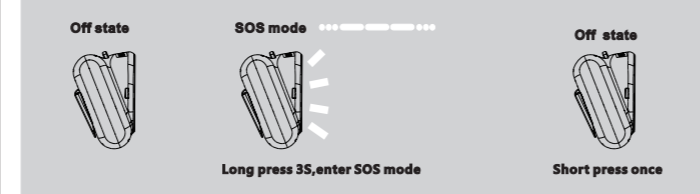

3.3.5 Battery Indicator

Press the button for more than 1.5 seconds when the lamp is off, the battery power indicator is on. The main light source and two auxiliary light sources flash a low light as the battery power status instructions.

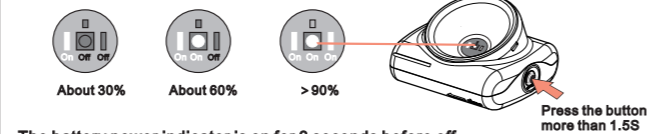

The battery power indicator is on for 3 seconds before off.
Note: The above status instructions are just for your reference.

3.4 Low battery warning

About 1 hour before the battery power is out, the main LED light of multi purpose lamp flashes softly (flashing one time for every five seconds) to remind the user that the power is nearly used up and needs to be recharged. If you don't want the flashing to affect the normal lighting, you can press the switch more than 2 seconds. The main light source will flash twice, and then the lamp restores to normal working. When the battery is only able to keep the cap lamp on for 10 minutes, its main light source will flash with the strong and soft light quickly (flashing one time for every two seconds). This information is to remind you that the battery is nearly used up and it needs recharging or change to the low light model.

3.5 Hold the lamp by the belt

You can use the belt to hold the WISDOM LAMP 3 for more convenient usage. There are one way as following:

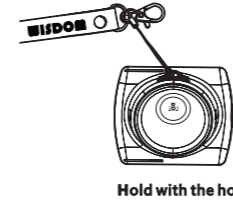

Hold with the hole

3.6 Optical lens

WISDOM LAMP 3 provides some kinds of optical lens to extend the usage range of the lamp. The lens assembly way:

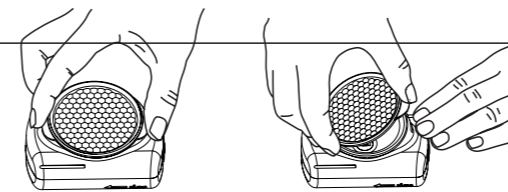

Picture 1 (installing operation)

Picture 2 (removing operation)

3.6.1 Optical lens 1

Put the optical lens 1 into the lens slot of multi-purpose lamp, which can change the original strong light into wider range of soft light. So WISDOM LAMP 3 with optical lens 1 is a kind of ideal lighting equipment for outdoor camping.

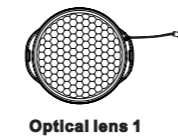

Optical lens 1



Lighting without optical lens



Lighting with optical lens 1

3.6.2 Optical lens 2

Put the optical lens 2 into the lens slot of multi purpose lamp, which can change the original strong light into narrower range of soft light. So WISDOM LAMP 3 with optical lens 2 is a kind of ideal lighting equipment for night reading.

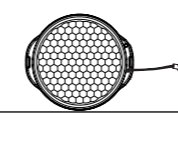

Optical lens 2



Lighting without optical lens



Lighting with optical lens 2

3.6.3 Optical lens 6

The optical lens 6 is specially designed for the lighting of the bicycle. Put the optical lens 3 into the lens slot of multi purpose lamp, which can widen the original strong light into a widely visible range. So it is a kind of ideal lighting equipment for night riding.



Optical lens 6



Lighting without optical lens



Lighting with optical lens 6

3.6.4 Optical lens 4

Put the optical lens 4 into the lens slot of multi-purpose lamp, which can change the originally simple light into colorful light. So WISDOM LAMP 3 with optical lens 4 is an ideal lighting equipment for night warning, for fun and so on.

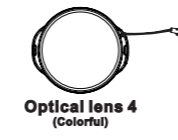

Optical lens 4 (Colorful)

3.7 Fix the lamp

You can not only fix WISDOM LAMP 3 on the cap but also on the wall with a nail.

4. Technical Specification of WISDOM LAMP 3

Features	Specifications				
	WISDOM LAMP 3A	WISDOM LAMP 3B	WISDOM LAMP 3C	WISDOM LAMP 3D	
Model	WISDOM LAMP 3A	WISDOM LAMP 3B	WISDOM LAMP 3C	WISDOM LAMP 3D	
Rated capacity	6.2Ah	4.4Ah	3.1Ah	2.2Ah	
Rated voltage	3.7V				
Main light LED Working Voltage	3.0V				
working time	Low light	60h			
	Middle light	16h			
	High light	6h			
Main light LED Working Current	Low light	65mA	50mA	50mA	40mA
	Middle light	450mA	350mA	220mA	170mA
	High light	1200mA	900mA	600mA	500mA
Main light Power	Low light	0.18W	0.14W	0.14W	0.11W
	Middle light	1.3W	1W	0.66W	0.45W
	High light	3.6W	2.7W	1.9W	1.45W
Main light Luminous flux	Low light	30Lm	23Lm	23Lm	18Lm
	Middle light	185Lm	148Lm	96Lm	75Lm
	High light	413Lm	330Lm	254Lm	203Lm
Lamp lighting degree Initial (degree in 1m)	Low light	1400Lux	900Lux	900Lux	650Lux
	Middle light	8500Lux	7000Lux	4500Lux	3000Lux
	High light	20000Lux	15500Lux	12000Lux	9000Lux
Main light life span	100000h				
Auxiliary light Power	0.4W				
Auxiliary light life span	40000h				
Short circuit protect time	<320μS				
Life span of the battery (recharges)	1200 times (In the reasonable working conditions)				
Charging time	5h	4h	4h	3h	
Dimensions	84x69x50mm				
Weight	175g	175g	128g	128g	

5. Trouble and Troubleshooting

Trouble Description	Trouble Analysis	Troubleshooting
Light is not on when pressing the button	Battery power is used up	Recharge the lamp
Working time is inconsistent with specifications	Battery is not fully charged	Make sure the lamp well connected to the power adaptor when charging
Longer charging time	The charging points is poor contacted	Clean the charging points and the slot

6. Notes

- WISDOM LAMP 3 is half charged before delivery, please fully charge it before using.
- Please use our own matched charger/charging rack or magnetic USB wire to charge the multi-purpose lamps, or the lamp may be damaged.
- If the lamps need storing for a long period, please repeat the following maintenance steps every two months: Fully charged → completely discharged → charged for 2 hours.
- Please clean up the dust in the charging point slot timely for the normal charging with the USB wire.
- Please keep it clean and take care of the magnetic USB wire and power supply for its normal use of mobile power bank.

7. Safety warnings

- Please don't shoot at eyes directly while the lamp is working since the strong light will hurt eyes.
- Please don't disassemble the cap lamp, or it may cause potential troubles related to safety, reliability to work underground.
- Please don't crash and strike the lamp.
- Please keep the lamp away from fire sources.
- Please recycle the discarded cap lamp together rather than throwing them away without disposing

Telephone : +86-755-83911841

www.wisdom.hk

Mailbox : info@wisdom.hk

Address: 4-306, xianglibincuen, Hongli West Road, shenzhen, China Zip code: 518034